

KEYSTONE

K-LOK® High Performance Butterfly Valves Sizes 2" to 36" ASME Class 150 and 300

Features and Benefits

- Integrally cast mounting pad provides direct mounting of many actuators.
- Rocker-shaped gland bridge compensates for uneven adjustment of gland nuts.
- Extended neck allows for two inches of pipeline insulation.
- Flattened body bore at stem journal ports positions stem bearings near disc, providing maximum stem support.
- Disc taper pins are tangentially positioned half in disc and half in stem, placing them in compression rather than shear, which eliminates potential for failure.
- Integrally cast disc position stop perfectly locates the disc in seat, achieving maximum seat and seal life.
- K-LOK polymer, elastomer, and fire-safe seats provide bi-directional, drop-tight closure in vacuum and throughout all pressure ranges, as well as at full rated differential pressure. A variety of materials allows optimum seat life in all applications.

General Applications

- Airport Refueling
- Hydrocarbon Processing
- HVAC
- Chemical Processing
- Purified Gas
- Steam and Vacuum Services
- Potable Water

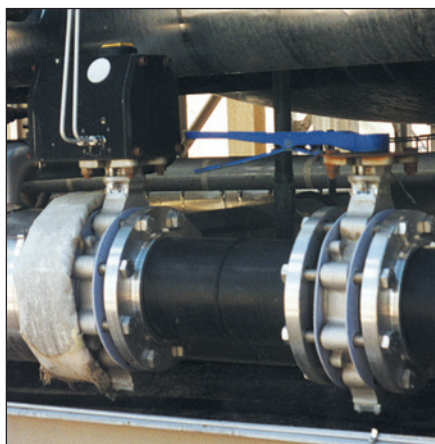
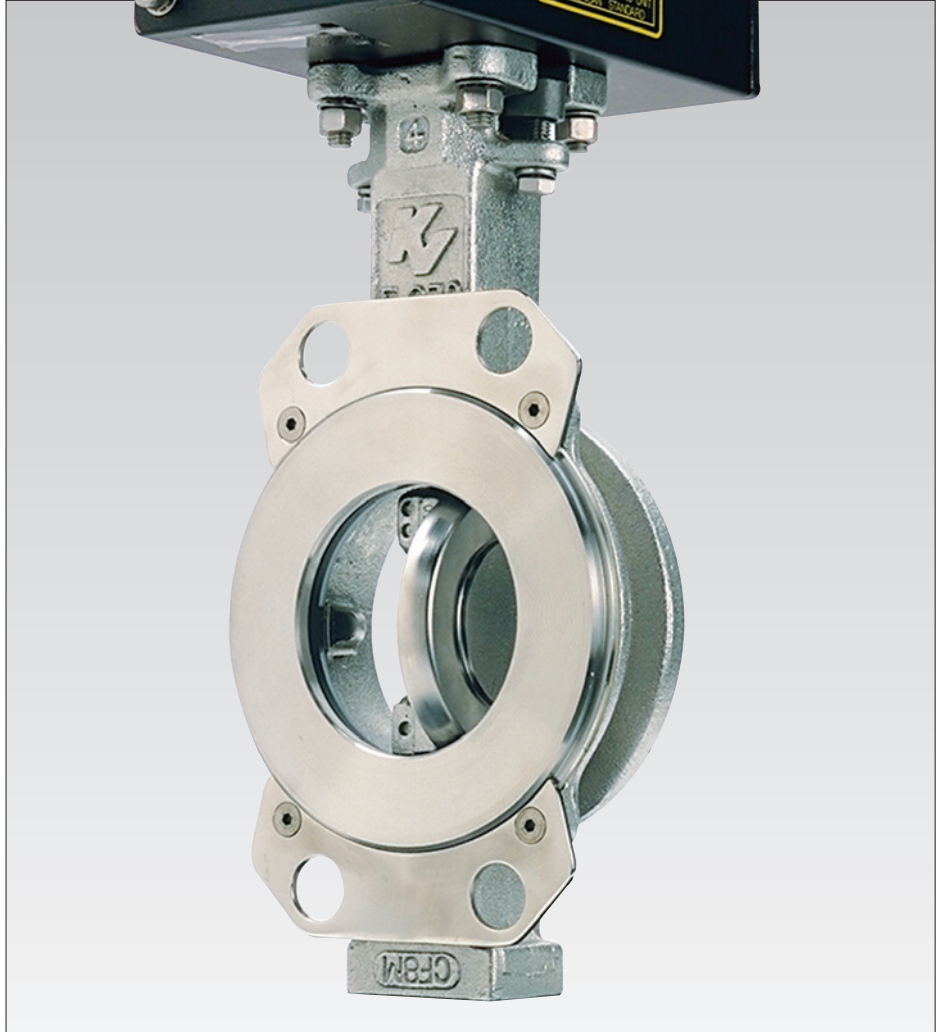

Technical Data

Size Range:	2" to 36"
Pressure Rating:	ASME Class 150 and 300
Temperature Rating:	-20°F to 1000°F
Fire-Safe Option	

Materials

Part	Material	Material Standard
1 Stem and taper pins	17-4 PH 316B SS NITRONIC 50® K-Monel® 500 Inconel® 718	ASTM A564 Condition H1075 or H1100 ASTM A276-316 Condition B (10" and smaller) ASTM A276-XM19 QQ-N-286 UNS N005500 Class A age-hardened
2 Body	Carbon steel Stainless steel Nickel aluminum bronze	ASTM A216-WCB ASTM A351-CF8M MIL B24480 CDA C95800/ASTM B148
3 Gland bridge	17-4PH stainless steel Carbon steel	
4 Packing gland follower	316 stainless steel	
5 Stem packing	PTFE Graphite Style 9000 EVSP simplified	
6 Stem bearing	316 stainless steel/Nitride, PTFE/Bronze, PTFE/Composite	
7 Body gasket	Non-asbestos fiber, Graphite PTFE	
8 Disc	316 stainless steel 316 stainless steel/ENP Monel®	ASTM A351-CF8M ASTM A351-CF8M/electroless nickel plated QQ-N-288 Composition A
9 Seat	Polymer Elastomer Metal Fire-safe	PTFE, RTFE, UHMWPE NBR, EPDM, Fluoroelastomer (FKM) 316 stainless steel, Monel® RTFE/316 stainless steel
10 Seat backing ring	Stainless steel	
11 Seat retainer ring	Carbon steel 316 Stainless steel Nickel aluminum bronze	
12 Flange locator plate	Stainless steel Carbon steel/zinc plated	
13 Disc locating shoulder	316 stainless steel	
14 Bottom cover gasket	Non-asbestos fiber or Graphite	
15 Bottom cover plate	316 stainless steel	
16 Thrust washer	Stainless steel/Nitride	

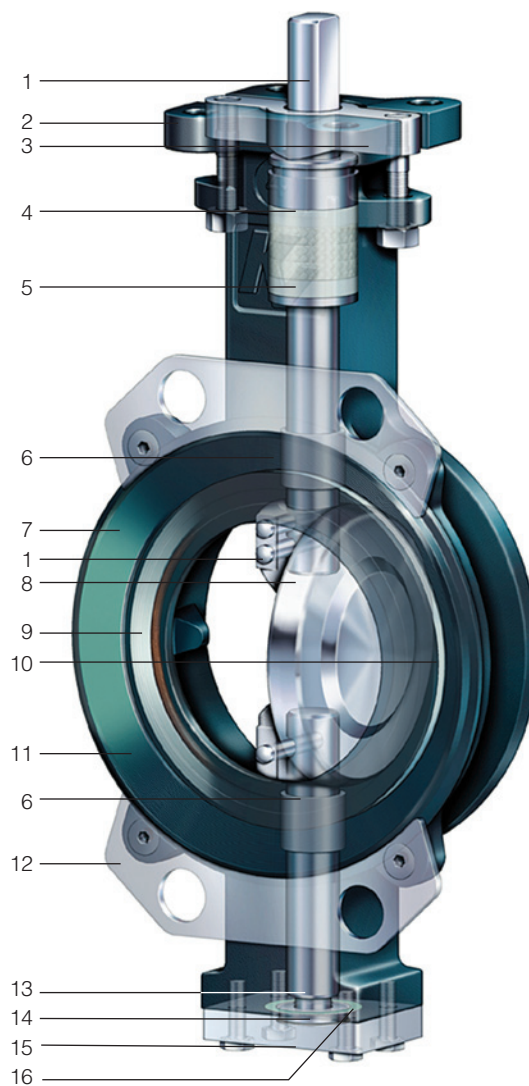

Recommended Standards and Specifications

ASME	- B16.34	Steel valves
	B31.1	Power piping (Sect 107)
	B31.3	Chemical plant and petroleum refinery piping
	B16.5	Steel pipe flanges and flange fittings
MSS	- SP-6	Standard finishes for pipe flanges
	SP-25	Standard marking systems for valves
	SP-55	Quality standard for steel casting
	SP-61	Pressure testing of steel valves
	SP-68	High pressure offset disc butterfly valves
API	- 609	Butterfly valves (most models)
	607	Fire test for soft seated quarter-turn valves
	598	Valve inspection and test
BS	- 5146	Inspection and test of steel valves for the petroleum, petrochemical and allied industries
	4504	Flanges and bolting for pipes, valves and fittings
JIS	- 2215	Basic dimensions for steel pipe flanges
NSF/ANSI	Standard 61	Potable water

Principles of Operation

Double Offset Disc/stem

K-LOK®'s unique two-piece stem and double-offset disc/stem design allows for high cycling and creates a lower disc profile with increased capacity and a range of 33:1.

In addition to increasing the flow area across the disc, this design minimizes wear points between seat and disc.

The first offset is achieved by locating the stems downstream of the center-line of the seat. This allows for a totally unobstructed 360° sealing surface.

The second offset locates the stems off-center of the vertical axis of the seat.

The combination of these two offsets creates a camming effect as the disc swings into and out of the seat. The disc lifts quickly out of the seat in the first few degrees of travel and does not contact the seat again until it is nearly closed. There are no wear points between the seat and disc, while operating torques are reduced and seat life is extended.

Double Offset

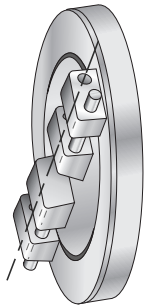

First Offset

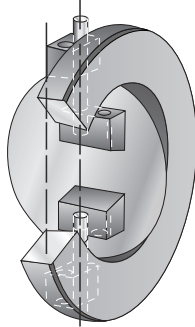

Second Offset

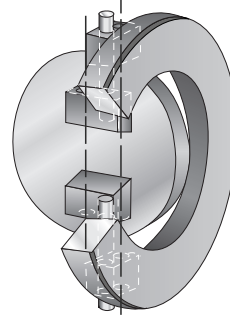

Two-piece Stem vs. One-piece Stem

K-LOK®'s disc geometry maximizes flow capacity by increasing the available flow area through the valve. This increase in disc efficiency results in a higher valve C_v .

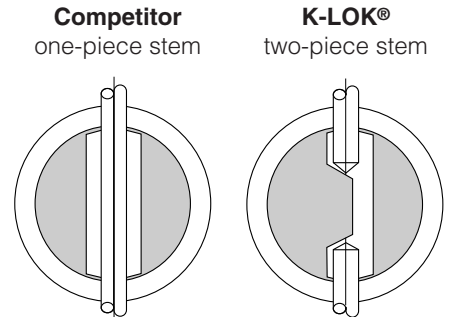

Aspect Ratio = Open Area ÷ Disc Area

Fire-Safe Valve

API 607 4th Edition Approved by Third Party Witness

The K-LOK fire-safe design uses a stainless steel or alloy seat of convoluted shape that mates with an RTFE member. In the full-closed position, the K-LOK provides continuous two-plane contact between the disc and both metal and RTFE seats. The fire-safe seat utilizes wire windings to provide the circumferential stiffness necessary to maintain interference between disc and seat.

Fire-Safe Packing

K-LOK fire-safe packing is composed of three rings of preformed graphite between one ring of woven graphite rope at the top and bottom.

This arrangement creates a superior, high temperature seal against the outer wall of the packing box and around the rotating stem.

Fire-Safe Seat

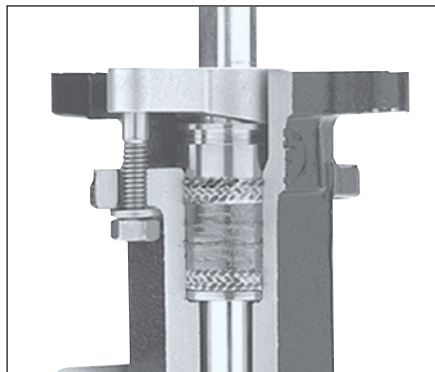
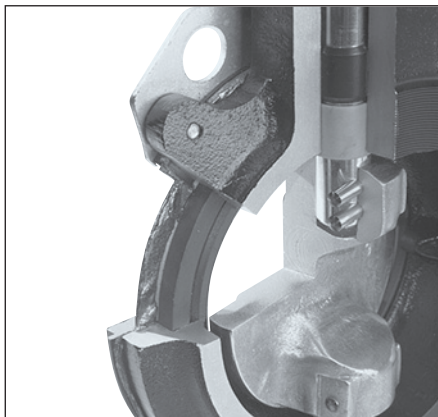

Seat Materials

Seat	Material	Typical Applications
1. PTFE	Polytetrafluoroethylene	Pharmaceuticals, water, jet fuel, river water, air
2. RTFE	Reinforced Polytetrafluoroethylene	Saturated steam, chlorine, ammonia, natural gas vacuum, oxygen, nitrogen
3. UHMWPE	Ultra high molecular weight	Abrasives, suspended solids, polyethylenescaling mediums
For Seats 1 thru 3		
Wire Wrap	Stainless steel braided wire	
Seat Backing Ring	Polyester, phenolic or	General purpose services stainless steel Steam, ammonia

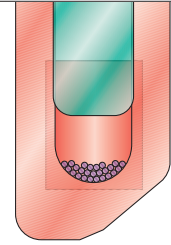

Seat	Material	Typical Applications
4. EPDM	-	Cooling water, chilled water,
5. NBR	-	HVAC, river water intakes,
6. Fluoroelastomer (FKM)	-	abrasives, vacuum
For Seats 4 thru 6		
Metal Insert	Carbon steel	

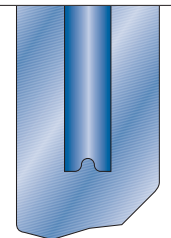

Seat	Material	Typical Applications
7. Metal	316 stainless steel or alloy (flash chrome coated)	High temperature, low temperature, abrasives, fly ash, slurries
For Seats 7 and 8		
8. Fire-safe	Reinforced polytetrafluoroethylene combined with 316 Stainless Steel (flash chrome coated)	Fire-safe installations, abrasives, slurries, steam
Wire Wrap	Stainless steel braided wire	

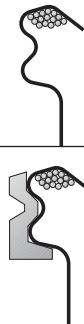

Seat Design

The K-LOK seat is a true interference seat design and does not rely on line pressure to assist in sealing. All seats seal drop-tight bi-directionally at low pressure as well as high pressure.

Polymer (PTFE, RTFE and UHMWPE) seats incorporate a stainless steel braided wire winding, enclosed in a U-shape envelope to provide seating energy and memory. This wire winding allows axial flexibility in both directions of flow. The winding also allows radial flexibility when the disc is not fully closed, reducing seat/disc interference, seat wear and stem torque. When the disc closes, it provides circumferential stiffness and assures the required disc/seat seals tight.

Elastomer seats are molded around a stack of V-shaped steel rings that provide the same stability, support and flexure as the wire windings in polymer seats.

Metal seats employ a stainless steel or alloy ring of convoluted shape, reinforced by stainless steel wire windings. The thin, convoluted shape allows for expansion and contraction from thermal cycling. Long life is assured by flash coating the seat with chrome.



ANSI/FCI 70-2 Control Valve Seat Leakage, Tolerances, and Test Specifications

ANSI B16.104-1976	Maximum Leakage		Test Medium	Pressure and Temperature	
Class VI	Nominal Port Diameter (in.)	Bubbles per Minute ³	ml. per Minute	Air or Nitrogen	Service ΔP or 50 psig [3.4 bar differential], whichever is lower, at 50° to 125°F [10° to 52°C]
	2	3	0.45		
	2½	4	0.60		
	3	6	0.90		
	4	11	1.70		
	6	27	4.00		
	8	45	6.75		
Class V	5 x 10-4 ml/min/psig/in. port dia. [5 x 10-12 m³/sec/bar differential/mm port dia.]			Water	Service ΔP at 50° to 125°F [10° to 52°C]
Class IV	0.01% valve capacity at full travel			Air or Water	Service ΔP or 50 psig [3.4 bar differential], whichever is lower, at 50° to 125°F [10° to 52°C]

Notes:

1. K-LOK polymer, elastomer and fire-safe seats provide ANSI Class VI shut-off.
2. K-LOK metal seats and firesafe seats (post fire exposure) provide ANSI Class IV shut-off.
3. Using the ANSI/FCI specified calibrated measuring device.

Reference ANSI/FCI 70-2 for further information.

C_v Values vs. Travel Position

Size (in.)	Angle of Opening								CL 150 90°	CL 300 90°
	10°	20°	30°	40°	50°	60°	70°	80°		
2	6	10	19	34	51	78	105	134	163	160
2½	6	10	19	34	53	80	111	148	175	170
3	8	12	24	43	67	100	139	186	220	215
4	16	23	44	80	130	194	269	360	425	413
5	30	44	83	149	242	366	504	673	795	785
6	50	70	130	230	370	550	760	1,010	1,195	1,140
8	83	117	251	437	695	1,052	1,496	2,001	2,440	2,300
10	144	202	454	754	1,185	1,821	2,611	3,541	4,540	4,333
12	208	304	678	1,051	1,625	2,766	3,838	5,325	6,915	6,600
14	257	360	747	1,186	1,909	3,121	4,416	6,225	8,300	7,920
16	308	432	803	1,422	2,289	3,614	5,251	7,530	10,040	9,580
18	373	548	1,121	1,869	2,990	4,735	6,728	9,845	12,460	11,890
20	463	680	1,390	2,315	4,010	6,175	8,795	12,655	15,430	14,720
24	650	991	2,076	3,803	6,060	9,091	13,301	18,466	21,660	20,665
30	1,015	1,550	3,240	4,670	9,460	14,200	21,400	29,800	36,000	35,500
36	1,460	2,300	4,640	5,950	13,700	21,000	30,400	44,000	56,000	55,500

Vacuum Rating

The combination of interference fit seats and bi-directional packing makes the K-LOK especially well suited for vacuum service.

Standard K-LOK high performance valves are rated to an absolute pressure of 4 x 10⁻⁵ inch Hg. Higher vacuum applications are available.

Common Available Trims

Figure Number	Valve Type
F360	ASME Class 150, Wafer
F362	ASME Class 150, Full-lug
F370	ASME Class 300, Wafer
F372	ASME Class 300, Full-lug

To order a K-LOK, specify the valve size, the valve figure number (listed above) and the specific application trim code. The most common codes, together with the materials of construction, are listed below. (Example: 10 inch F360-104)

General Purpose Trims (up to 250°F)

Trim Code	Body	Disc	Shaft	Seat/Backing Ring
106	Steel	316 SS/ENP	17-4PH SS	UHMWPE/SS
107	316 SS	316 SS/ENP	17-4PH SS	UHMWPE/SS

General Purpose Trims (up to 500°F)

Trim Code	Body	Disc	Shaft	Seat/Backing Ring
123	Steel	316 SS/ENP	17-4PH SS	RTFE/SS
124	316 SS	316 SS/ENP	17-4PH SS	RTFE/SS
158	Steel	316 SS	17-4PH SS	RTFE/SS
159	316 SS	316 SS	17-4PH SS	RTFE/SS

Metal Seated – High Temperature Trims

Trim Code	Body	Disc	Shaft	Seat/Backing Ring
113	Steel	316 SS/ENP	17-4PH SS	316 SS chrome plated
114	316 SS	316 SS/ENP	17-4PH SS	316 SS chrome plated

Corrosion Resistant Trims

Trim Code	Body	Disc	Shaft	Seat/Backing Ring
133	316 SS	316 SS	316 SS Cond. B	RTFE/SS
134	316 SS	316 SS	NITRONIC 50®	RTFE/SS

Fire-Safe Trims

Trim Code	Body	Disc	Shaft	Seat/Backing Ring
115	Steel	316 SS/ENP	17-4PH SS	316 SS chrome plated and RTFE
116	316 SS	316 SS/ENP	17-4PH SS	316 SS chrome plated and RTFE

Note:

Other trims are available; please contact your sales representative.

Seating and Un-seating Torque

Seating and un-seating torques are a function of the size of the valve and the shut-off pressure of the system.

Specific torque ratings can be found in the Seating/Un-seating chart at the intersection of the 'size' row and the 'shut-off pressure' column.

Torques listed are for PTFE and RTFE seated valves. For different seat materials specific multipliers are to be used as stated.

All torques listed are for normal service conditions (i.e. operating frequency is a minimum of once per month; disc corrosion is expected to be mild or minor, the media is a clean gas, liquid or steam, and is non-abrasive) and chemical effects upon the seat are minor.

PTFE and RTFE Bi-Directional Seating and Un-Seating Torque Values								
Valve Size (inch)	Shaft Mounting Code (ASME)		Seating and Un-seating Torque (lbs. in.)					
	150	300	System Shut-off Pressure (psig)					
			150	200	285	400	500	740
2	BAB	BAB	220	280	380	460	520	580
2½	BAB	BAB	220	280	380	460	520	580
3	BAC	BAC	250	320	430	520	590	650
4	BAD	BAD	475	600	820	995	1,120	1,235
5	BAD	BAD	925	1,125	1,350	1,570	1,750	1,900
6	CAD/CAE*	CAE	1,370	1,600	1,850	2,150	2,390	2,900
8	CAF	CAF	2,060	2,330	3,200	4,020	4,870	6,720
10	CAF/CAG*	CAG	3,340	3,650	4,700	6,250	7,450	9,850
12	DAG	DAG	4,590	5,250	6,400	8,160	9,690	12,940
14	DAH	DAJ	6,750	7,560	9,150	11,450	13,300	17,200
16	DAH	DAK	9,350	10,450	12,600	15,000	17,500	22,200
18	DAJ	DBA	11,900	13,300	15,800	19,500	21,900	28,500
20	DAK	LAX	15,600	17,500	21,000	25,200	28,700	36,140
24	DAK	MAY	21,700	25,340	30,600	36,900	42,100	54,000
30	MAZ	NAW	29,200	35,000	43,500	54,500	62,500	80,000
36	MBE	EBD	52,500	58,500	70,000	85,000	97,500	125,000

*CAE and CAG mounting codes apply for shaft mounting of UHMWPE, metal and fire-safe seats.

Notes:

- Torques are applicable only to PTFE and RTFE seats in noncorrosive or non-abrasive services such as water. For fire-safe and metal seats, select only the torque for the valve at 285 psig and multiply by 2.0.
- For other seat materials, select the torque applicable for the maximum differential pressure and multiply by the following factor:
 EPDM/NBR/Fluoroelastomer (FKM): x 1.4
 UHMWPE (Clean Service): x 1.3
- For corrosive, abrasive or other services than water, multiply by the following factor:
 High solids slurry: x 1.5
 Dry gas: x 2.0
 Dry powders: x 2.7
 Liquids other than water: x 1.2
 Lubricating fluids: x 0.8
 For services that combine unfriendly conditions such as extreme temperatures and high solids, or corrosive with high temperatures, contact the factory.

Extension Brackets For Various Temperatures

Pipeline Fluid Temperature	Required Extension Lengths (inches)				Standard F777
	Handle	Gear	200°F Std. F79U	450°F High Temp. F79U	
-100°F - 375°F	–	–	–	–	–
376°F - 460°F	4	–	–	–	4
461°F - 560°F	6	4	4	–	4
561°F - 650°F	6	4	4	–	4
651°F - 725°F	6	6	6	4	6
726°F - 825°F	8	8	8	6	8
826°F - 925°F	10	8	8	6	8
926°F - 1,000°F	10	10	10	8	10

Notes:

1. Surrounding air temperature is assumed to be 70°F. For every degree over 100°F of the surrounding air, deduct 2 degrees from the temperature ranges shown above.
(Example: 125°F external reduces maximum temperature values to 325, 410, 510, 600, etc.)
2. Valves may be insulated or uninsulated.
3. Brackets may be open rectangular tubes or the standard closed Keystone tubular stem extensions.
4. All actuators have a maximum service temperature (outside atmosphere). These temperature limitations apply regardless of K-LOK extension lengths.

Flange Gaskets

The K-LOK high performance butterfly valve is designed to accommodate the use of standard, non-metallic gaskets for pipe flanges (such as compressed fiber, rubber, non-asbestos, flexible graphite, asbestos or equivalent gasket materials), meeting the dimensional requirements of ASME B16.21-1992. Metallic wound gaskets may also be used, however, please note that any valve with a bolted on retainer requires the wound gaskets material to be manufactured to the following dimensions (inches):

	Outside Diameter	Inside Diameter
2	3 ³ / ₈	2 ³ / ₄
2 ¹ / ₂	3 ⁷ / ₈	3 ¹ / ₄
3	4 ³ / ₄	4
4	5	4 ¹ / ₈
5	6 ¹ / ₈	5 ¹ / ₄
6	7 ³ / ₁₆	6 ¹ / ₄
8	9 ³ / ₁₆	8
10	11 ⁵ / ₁₆	10 ¹ / ₈
12	13	11 ¹ / ₂
14	14 ¹ / ₂	13
16	16 ¹ / ₂	14 ³ / ₄
18	18	16
20	19 ³ / ₄	18
24	26 ¹ / ₄	24
30	29 ¹ / ₂	27 ¹ / ₂
36	36 ¹ / ₂	34 ¹ / ₄

K-LOK Services

Many services have specific requirements. Tyco Flow Control can meet most of these needs. The K-LOK product line can be ordered for the following special services:

- Food processing
- Sour gas
- Military
- Vacuum
- Oxygen
- Pharmaceutical
- Ammonia
- Chlorine
- Reverse osmosis
- Category 'M' fluids
- Slurry
- Modulating control
- Steam

Recommended Flange Bolt Lengths

Lugged Body 150 Class - Fig. 362						
Valve Size (in.)	Hex Head Machine Bolt			All Thread		
	Qty.	Size	Length (in.)	Qty.	Size	Length (in.)
2	4	5/8 - 11UNC	x 1 3/4	4	5/8 - 11UNC	x 2 1/2
	4	5/8 - 11UNC	x 2	4	5/8 - 11UNC	x 2 3/4
2 1/2	8	5/8 - 11UNC	x 1 3/4	8	5/8 - 11UNC	x 2 1/2
3	4	5/8 - 11UNC	x 2	4	5/8 - 11UNC	x 2 3/4
	4	5/8 - 11UNC	x 1 1/2	4	5/8 - 11UNC	x 2 1/2
4	8	5/8 - 11UNC	x 2	8	5/8 - 11UNC	x 2 3/4
	8	5/8 - 11UNC	x 1 3/4	8	5/8 - 11UNC	x 2 1/2
5	16	3/4 - 10UNC	x 2	16	3/4 - 10UNC	x 3
	8	3/4 - 10UNC	x 2 1/4	8	3/4 - 10UNC	x 3
6	8	3/4 - 10UNC	x 2	8	3/4 - 10UNC	x 3 1/4
	8	3/4 - 10UNC	x 2 1/2	8	3/4 - 10UNC	x 3 1/2
8	8	3/4 - 10UNC	x 2 1/2	8	3/4 - 10UNC	x 3 1/2
	8	3/4 - 10UNC	x 2	8	3/4 - 10UNC	x 3
10	12	7/8 - 9UNC	x 2 3/4	12	7/8 - 9UNC	x 4
	12	7/8 - 9UNC	x 2 1/4	12	7/8 - 9UNC	x 3 1/4
12	12	7/8 - 9UNC	x 3	12	7/8 - 9UNC	x 4
	12	7/8 - 9UNC	x 2 1/2	12	7/8 - 9UNC	x 3 3/4
14	12	1 - 8UN	x 3 1/2	12	1 - 8UN	x 4 3/4
	12	1 - 8UN	x 3	12	1 - 8UN	x 4 1/4
16	32	1 - 8UN	x 3	32	1 - 8UN	x 4
18	32	1 1/8 - 8UN	x 3 3/4	32	1 1/8 - 8UN	x 5
	8	1 1/8 - 8UN	x 3	8	1 1/8 - 8UN	x 4 1/2
20	32	1 1/8 - 8UN	x 4	32	1 1/8 - 8UN	x 5 1/2
	8	1 1/8 - 8UN	x 3	8	1 1/8 - 8UN	x 4 1/2
24	20	1 1/4 - 8UN	x 5	20	1 1/4 - 8UN	x 6 1/2
	20	1 1/4 - 8UN	x 4 1/2	20	1 1/4 - 8UN	x 6
30	48	1 1/4 - 8UN	x 6	48	1 1/4 - 8UN	x 7 1/2
	8	1 1/4 - 8UN	x 4 1/2	8	1 1/4 - 8UN	x 6
36	28	1 1/2 - 8UN	x 7 1/2	28	1 1/2 - 8UN	x 9 1/2
	28	1 1/2 - 8UN	x 7	28	1 1/2 - 8UN	x 9
	4	1 1/2 - 8UN	x 5	4	2 - 8UN	x 7
	4	1 1/2 - 8UN	x 6	4	2 - 8UN	x 8

Lugged Body 300 Class - Fig. 372						
Valve Size (in.)	Hex Head Machine Bolt			All Thread		
	Qty.	Size	Length (in.)	Qty.	Size	Length (in.)
2	16	5/8 - 11UNC	x 2	16	5/8 - 11UNC	x 3
2 1/2	8	3/4 - 10UNC	x 1 3/4	8	3/4 - 10UNC	x 2 3/4
	8	3/4 - 10UNC	x 2	8	3/4 - 10UNC	x 2 3/4
3	8	3/4 - 10UNC	x 2 1/4	8	3/4 - 10UNC	x 3 1/4
	8	3/4 - 10UNC	x 1 3/4	8	3/4 - 10UNC	x 2 3/4
4	8	3/4 - 10UNC	x 2 1/2	8	3/4 - 10UNC	x 3 1/4
	8	3/4 - 10UNC	x 2	8	3/4 - 10UNC	x 3
5	8	3/4 - 10UNC	x 2 1/2	16	3/4 - 10UNC	x 3 1/2
	8	3/4 - 10UNC	x 2 1/4			
6	12	3/4 - 10UNC	x 2 3/4	24	3/4 - 10UNC	x 3 1/2
	12	3/4 - 10UNC	x 2 1/4			
8	12	7/8 - 9UNC	x 3 1/4	12	7/8 - 9UNC	x 4 1/2
	12	7/8 - 9UNC	x 2 1/2	12	7/8 - 9UNC	x 3 1/2
10	16	1 - 8UN	x 3 3/4	16	1 - 8UN	x 5
	16	1 - 8UN	x 3	16	1 - 8UN	x 4 1/4
12	16	1 1/8 - 8UN	x 4	16	1 1/8 - 8UN	x 5 1/2
	16	1 1/8 - 8UN	x 3 1/2	16	1 1/8 - 8UN	x 4 3/4
14	16	1 1/8 - 8UN	x 4 1/2	16	1 1/8 - 8UN	x 6
	16	1 1/8 - 8UN	x 4	16	1 1/8 - 8UN	x 5 1/2
16	4	1 1/8 - 8UN	x 3 1/4	4	1 1/8 - 8UN	x 4 3/4
	4	1 1/8 - 8UN	x 3	4	1 1/8 - 8UN	x 4 1/2
18	16	1 1/4 - 8UN	x 5	16	1 1/4 - 8UN	x 6 1/2
	16	1 1/4 - 8UN	x 4 1/2	16	1 1/4 - 8UN	x 6
20	8	1 1/4 - 8UN	x 3 1/2	8	1 1/4 - 8UN	x 5
	40	1 1/4 - 8UN	x 5	40	1 1/4 - 8UN	x 6 1/2
24	40	1 1/4 - 8UN	x 5 1/2	40	1 1/4 - 8UN	x 7
	4	1 1/4 - 8UN	x 4	4	1 1/4 - 8UN	x 5 1/2
30	4	1 1/4 - 8UN	x 4 1/2	4	1 1/4 - 8UN	x 6
	40	1 1/2 - 8UN	x 6	40	1 1/2 - 8UN	x 8
36	4	1 1/2 - 8UN	x 5	4	1 1/2 - 8UN	x 7
	4	1 1/2 - 8UN	x 4 1/2	4	1 1/2 - 8UN	x 6 1/2
30	48	1 3/4 - 8UN	x 7	48	1 3/4 - 8UN	x 9
	8	1 3/4 - 8UN	x 5 1/2	8	1 3/4 - 8UN	x 7 1/2

Wafer Body 150 Class - Fig. 360						
Valve Size (in.)	Hex Head Machine Bolt			All Thread		
	Qty.	Size	Length (in.)	Qty.	Size	Length (in.)
2	4	5/8 - 11UNC	x 5	4	5/8 - 11UNC	x 5 1/2
2 1/2	4	5/8 - 11UNC	x 4 1/2	4	5/8 - 11UNC	x 5
3	4	5/8 - 11UNC	x 4 1/2	4	5/8 - 11UNC	x 5 1/4
4	8	5/8 - 11UNC	x 4 3/4	8	5/8 - 11UNC	x 5 1/2
5	8	3/4 - 10UNC	x 5	8	3/4 - 10UNC	x 6
6	8	3/4 - 10UNC	x 5 1/4	8	3/4 - 10UNC	x 6
8	8	3/4 - 10UNC	x 5 3/4	8	3/4 - 10UNC	x 6 1/2
10	12	7/8 - 9UNC	x 6 1/4	12	7/8 - 9UNC	x 7
12	12	7/8 - 9UNC	x 7	12	7/8 - 9UNC	x 7 1/2
14	12	1 - 8UN	x 7 1/2	12	1 - 8UN	x 8 1/2
16	16	1 - 8UN	x 8	16	1 - 8UN	x 9
18	16	1 1/8 - 8UN	x 9 1/4	16	1 1/8 - 8UN	x 10 1/2
20	16	1 1/8 - 8UN	x 10	16	1 1/8 - 8UN	x 11
	4	1 1/8 - 8UN	x 3 1/2	4	1 1/8 - 8UN	x 5
24	4	1 1/8 - 8UN	x 3	4	1 1/8 - 8UN	x 4 1/2
	20	1 1/4 - 8UN	x 11 1/2	20	1 1/4 - 8UN	x 12 1/2
30	24	1 1/4 - 8UN	x 13 1/4	24	1 1/4 - 8UN	x 16
	4	1 1/4 - 8UN	x 3 1/2	4	1 1/4 - 8UN	x 5 1/4
36	4	1 1/4 - 8UN	x 3 1/4	4	1 1/4 - 8UN	x 4 3/4
	28	1 1/2 - 8UN	x 15	28	1 1/2 - 8UN	x 18 3/4
36	4	1 1/2 - 8UN	x 5	4	1 1/2 - 8UN	x 6 3/4
	4	1 1/2 - 8UN	x 4	4	1 1/2 - 8UN	x 6

Wafer Body 300 Class - Fig. 370						
Valve Size (in.)	Hex Head Machine Bolt			All Thread		
	Qty.	Size	Length (in.)	Qty.	Size	Length (in.)
2	8	5/8 - 11UNC	x 5 1/4	8	5/8 - 11UNC	x 5 3/4
2 1/2	8	3/4 - 10UNC	x 4 3/4	8	3/4 - 10UNC	x 5 1/2
3	8	3/4 - 10UNC	x 5	8	3/4 - 10UNC	x 5 3/4
4	8	3/4 - 10UNC	x 5 1/2	8	3/4 - 10UNC	x 6 1/2
5	8	3/4 - 10UNC	x 6	8	3/4 - 10UNC	x 7
6	12	3/4 - 10UNC	x 6	12	3/4 - 10UNC	x 7
8	12	7/8 - 9UNC	x 7 1/4	12	7/8 - 9UNC	x 8
10	12	1 - 8UN	x 8 1/4	12	1 - 8UN	x 9 1/2
	4	1 - 8UN	x 3 7/8	4	1 - 8UN	x 4 7/8
12	4	1 - 8UN	x 3 1/8	4	1 - 8UN	x 4 1/8
	16	1 1/8 - 8UN	x 9	16	1 1/8 - 8UN	x 10
14	16	1 1/8 - 8UN	x 10 1/4	16	1 1/8 - 8UN	x 11 1/2
	4	1 1/8 - 8UN	x 3 1/4	4	1 1/8 - 8UN	x 4 3/4
16	4	1 1/8 - 8UN	x 3	4	1 1/8 - 8UN	x 4 1/2
	16	1 1/4 - 8UN	x 11 1/2	16	1 1/4 - 8UN	x 12 1/2
18	4	1 1/4 - 8UN	x 3 1/4	4	1 1/4 - 8UN	x 4 3/4
	4	1 1/4 - 8UN	x 3	4	1 1/4 - 8UN	x 4 1/2
20	20	1 1/4 - 8UN	x 12	20	1 1/4 - 8UN	x 13 1/2
	4	1 1/4 - 8UN	x 3 1/2	4	1 1/4 - 8UN	x 5
24	4	1 1/4 - 8UN	x 3	4	1 1/4 - 8UN	x 4 3/4
	20	1 1/2 - 8UN	x 14 1/2	20	1 1/2 - 8UN	x 16
30	4	1 1/2 - 8UN	x 4 3/4	4	1 1/2 - 8UN	x 6 1/2
	4	1 1/2 - 8UN	x 4 1/4	4	1 1/2 - 8UN	x 6 1/4
36	24	1 1/2 - 8UN	x 19	24	1 3/4 - 8UN	x 20 1/2
	8	1 3/4 - 8UN	x 5 1/2	8	1 3/4 - 8UN	x 7 3/4

Wafer Body

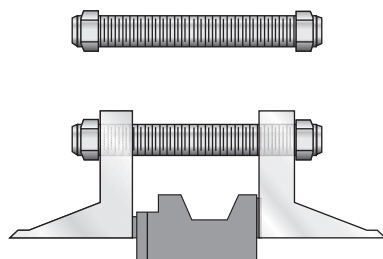

Lugged Body

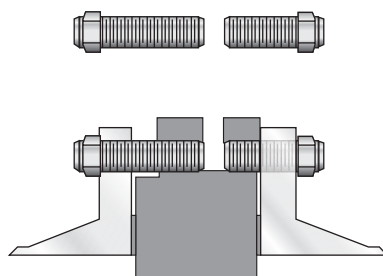

Wafer Style

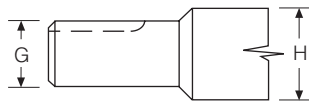

Upper Shaft/Keyway
8" to 24"

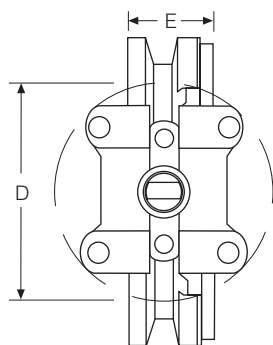

Top Plate View

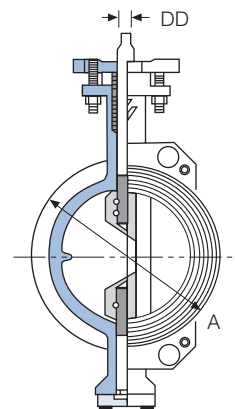
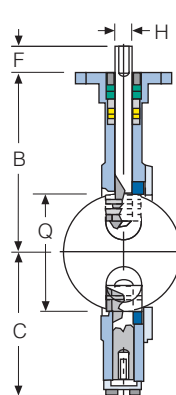

ASME Class 150 Figure 360 Dimensions (inches)

Size	A	B	C	D	E	F	G	H	Q	Top Plate Drilling			Wt. Lbs.	Actuator Code	
										DD or Keyway	Bolt Circle	No. Holes Dia.			
2	4 1/8	6	4 1/4	4	2 3/8	1 1/4	N/A	9/16	1 7/8	3/8	3 1/4	4	7/16	8	BAB
2 1/2	4 1/8	6	4 1/4	4	1 7/8	1 1/4	N/A	9/16	2 5/16	3/8	3 1/4	4	7/16	9	BAB
3	5	6 5/8	4 13/16	4	1 7/8	1 1/4	N/A	5/8	2 3/4	7/16	3 1/4	4	7/16	12	BAC
4	6 3/16	7 1/2	5 13/16	4	2 1/8	1 1/4	N/A	3/4	3 1 1/16	1/2	3 1/4	4	7/16	20	BAD
5	7 1/4	7 9/16	5 13/16	4	2 1/4	1 1/4	N/A	3/4	4 3/4	1/2	3 1/4	4	7/16	25	BAD
6	8 19/32	8 3/4	6 15/16	6	2 1/4	1 1/4	3/4	7/8	5 5/8	1/2	5	4	9/16	32	CAD
6*	8 19/32	8 3/4	6 15/16	6	2 1/4	1 1/4	N/A	7/8	5 5/8	5/8	5	4	9/16	33	CAE
8	10 5/8	10 1/8	8 3/8	6	2 1/2	2	N/A	1 1/8	7 7/16	1/4 X 1/4 X 1 5/8	5	4	9/16	50	CAF
10	12 3/4	11 3/8	9 11/16	6	2 13/16	2	1 1/8	1 3/8	9 7/16	1/4 X 1/4 X 1 5/8	5	4	9/16	77	CAF
10*	12 3/4	11 3/8	9 11/16	6	2 13/16	3	N/A	1 3/8	9 7/16	5/16 X 5/16 X 2 5/8	5	4	9/16	78	CAG
12	14 3/4	13	10 7/8	8	3 3/16	3	1 3/8	1 1/2	11 1/4	5/16 X 5/16 X 2 5/8	6 1/2	4	13/16	124	DAG
14	16 1/4	13 1/4	11 7/8	8	3 5/8	3	N/A	1 5/8	12 5/16	3/8 X 3/8 X 2 5/8	6 1/2	4	13/16	141	DAH
16	18 1/2	14 1/2	12 7/8	8	4	3	1 5/8	1 3/4	14 1/8	3/8 X 3/8 X 2 5/8	6 1/2	4	13/16	230	DAH
18	21	16	13 7/8	8	4 1/2	4 1/16	N/A	1 7/8	15 15/16	1/2 X 3/8 X 4 1/16	6 1/2	4	13/16	305	DAJ
20	23	17 7/16	15 7/16	8	5	4 5/16	N/A	2 1/4	17 5/8	1/2 X 3/8 X 4	6 1/2	4	13/16	350	DAK
24	27 1/2	19 11/16	17 13/16	8	6 1/16	4 1/4	2 1/4	2 1/2	21 1/16	1/2 X 3/8 X 4	6 1/2	4	13/16	620	DAK
30	33 3/4	24 1/2	21 3/16	9 1/2	7 3/8	7	N/A	3	26 7/8	3/4 X 3/4 X 6	9 3/4	4	1 1/16	1,020	MAZ
36	40 1/4	28 3/8	24 11/16	9 1/2	8 1/2	8	N/A	3 1/2	33 5/16	7/8 X 7/8 X 5 11/16	9 3/4	4	1 1/16	1,850	MBE

Note:

* E.N.P. discs require larger upper stem connection diameters on 6 inch and 10 inch valve sizes for UHMWPE seat, metal seat and fire-safe seat trims.

ASME Class 300 Figure 370 Dimensions (inches)

Size	A	B	C	D	E	F	G	H	Q	Top Plate Drilling			Tapped Lug Data			Wt. Lbs.	Actuator Code	
										DD or Keyway	Bolt Circle	No. Holes Dia.	No. Holes	Bolt Circle	Tap			
2	4 1/8	6	4 1/4	4	2 3/8	1 1/4	N/A	9/16	1 7/8	3/8	3 1/4	4	7/16	—	—	—	8	BAB
2 1/2	4 1/8	6	4 1/4	4	1 7/8	1 1/4	N/A	9/16	2 5/16	3/8	3 1/4	4	7/16	—	—	—	9	BAB
3	5	6 5/8	4 13/16	4	1 7/8	1 1/4	N/A	5/8	2 11/16	7/16	3 1/4	4	7/16	—	—	—	12	BAC
4	6 3/16	7 1/2	5 13/16	4	2 1/8	1 1/4	N/A	3/4	3 1 1/16	1/2	3 1/4	4	7/16	—	—	—	20	BAD
5	7 1/4	7 9/16	5 13/16	4	2 5/16	1 1/4	N/A	3/4	4 3/4	1/2	3 1/4	4	7/16	—	—	—	25	BAD
6	8 19/32	8 3/4	6 15/16	6	2 5/16	1 1/4	N/A	7/8	5 5/8	5/8	5	4	9/16	—	—	—	32	CAE
8	10 5/8	10 1/8	8 3/8	6	2 7/8	2	N/A	1 1/8	7 7/16	1/4 X 1/4 X 1 5/8	5	4	9/16	—	—	—	65	CAF
10	12 3/4	11 3/8	9 11/16	6	3 1/4	3	N/A	1 3/8	9 3/8	5/16 X 5/16 X 2 5/8	5	4	9/16	4	15 1/4	1-8UN	95	CAG
12	14 3/4	13	10 7/8	8	3 3/8	3	1 3/8	1 1/2	11 1/4	5/16 X 5/16 X 2 5/8	6 1/2	4	13/16	—	—	—	145	DAG
14	16 1/4	14 3/8	12 5/8	8	4 5/8	4 1/4	N/A	1 7/8	12	1/2 X 3/8 X 4 1/16	6 1/2	4	13/16	4	20 1/4	1 1/8-8UN	270	DAJ
16	18 1/2	16 1/16	13 3/4	8	5 1/4	4 1/8	N/A	2 1/4	13 5/8	1/2 X 3/8 X 4	6 1/2	4	13/16	4	22 1/2	1 1/4-8UN	305	DAK
18	21	17	15 1/8	8	5 7/8	4 7/32	N/A	2 1/2	15 7/16	5/8 X 5/8 X 4	6 1/2	4	13/16	4	24 3/4	1 1/4-8UN	385	DBA
20	23	20 3/16	16 3/4	7 1/2	6 1/4	6 1/2	N/A	2 3/4	17 1/4	5/8 X 5/8 X 6 3/8	8	4	13/16	4	27	1 1/4-8UN	450	LAX
24	27 1/4	23 3/8	19 13/16	9 1/2	7 1/8	6 13/16	N/A	3 1/2	20 3/4	7/8 X 7/8 X 5 11/16	9 3/4	4	1 1/16	4	32	1 1/2-8UN	770	MAY
30	33 3/4	26 5/8	24 9/16	10	9 1/2	7 7/8	N/A	4 1/2	26	1 X 1 X 6 1/2	10	4	1 1/8	4	39 1/4	1 3/4-8UN	1,100	NAW
36	40 1/4	30 7/8	28 7/16	12 1/4	10 3/4	8	N/A	5	32 7/16	1 1/4 X 1 1/4 X 7	12	4	1 1/8	4	46	2-8UN	1,590	EBD

Lug Style

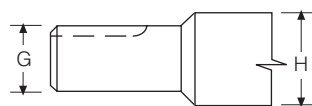

Upper Shaft/Keyway
8" to 24"

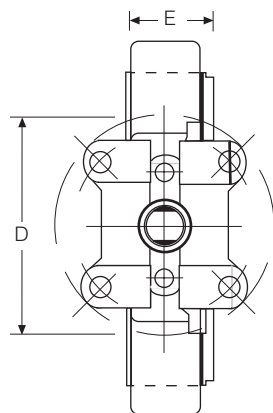

Top Plate View

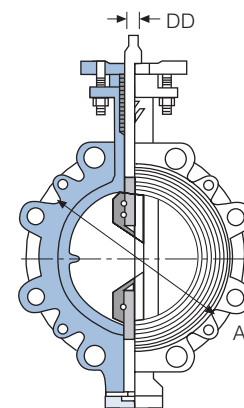
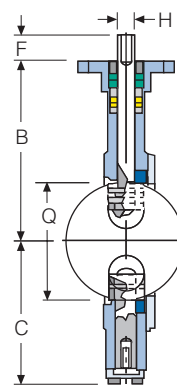

ASME Class 150 Figure 362 Dimensions (inches)

Size	A	B	C	D	E	F	G	H	Q	Top Plate Drilling			Tapped Lug Data			Wt. Lbs.	Actuator Code	
										DD or Keyway	Bolt Circle	No. Holes	Hole Dia.	No. Holes	Bolt Circle			Tap
2	4 1/8	6	4 1/4	4	2 3/8	1 1/4	N/A	9/16	1 7/8	3/8	3 1/4	4	7/16	4	4 3/4	5/8-11UNC	13	BAB
2 1/2	4 1/8	6	4 1/4	4	1 7/8	1 1/4	N/A	9/16	2 5/16	3/8	3 1/4	4	7/16	4	5 1/2	5/8-11UNC	14	BAB
3	5	6 5/8	4 13/16	4	1 7/8	1 1/4	N/A	5/8	2 3/4	7/16	3 1/4	4	7/16	4	6	5/8-11UNC	15	BAC
4	6 3/16	7 1/2	5 13/16	4	2 1/8	1 1/4	N/A	3/4	3 11/16	1/2	3 1/4	4	7/16	8	7 1/2	5/8-11UNC	26	BAD
5	7 1/4	7 9/16	5 13/16	4	2 1/4	1 1/4	N/A	3/4	4 3/4	1/2	3 1/4	4	7/16	8	8 1/2	3/4-10UNC	31	BAD
6	8 19/32	8 3/4	6 15/16	6	2 1/4	1 1/4	3/4	7/8	5 5/8	1/2	5	4	9/16	8	9 1/2	3/4-10UNC	40	CAD
6*	8 19/32	8 3/4	6 15/16	6	2 1/4	1 1/4	N/A	7/8	5 5/8	5/8	5	4	9/16	8	9 1/2	3/4-10UNC	41	CAE
8	10 5/8	10 1/8	8 3/8	6	2 1/2	2	N/A	1 1/8	7 7/16	1/4 X 1/4 X 1 5/8	5	4	9/16	8	11 3/4	3/4-10UNC	63	CAF
10	12 3/4	11 3/8	9 11/16	6	2 13/16	2	1 1/8	1 3/8	9 7/16	1/4 X 1/4 X 1 5/8	5	4	9/16	12	14 1/4	7/8-9UNC	106	CAF
10*	12 3/4	11 3/8	9 11/16	6	2 13/16	3	N/A	1 3/8	9 7/16	5/16 X 5/16 X 2 5/8	5	4	9/16	12	14 1/4	7/8-9UNC	107	CAG
12	14 3/4	13	10 7/8	8	3 3/16	3	1 3/8	1 1/2	11 1/4	5/16 X 5/16 X 2 5/8	6 1/2	4	13/16	12	17	7/8-9UNC	160	DAG
14	16 1/4	13 1/4	11 7/8	8	3 5/8	3	N/A	1 5/8	12 5/16	3/8 X 3/8 X 2 5/8	6 1/2	4	13/16	12	18 3/4	1-8UN	265	DAH
16	18 1/2	14 1/2	12 7/8	8	4	3	1 5/8	1 3/4	14 1/8	3/8 X 3/8 X 2 5/8	6 1/2	4	13/16	16	21 3/4	1-8UN	305	DAH
18	21	16	13 7/8	8	4 1/2	4 1/16	N/A	1 7/8	15 15/16	1/2 X 3/8 X 4 1/16	6 1/2	4	13/16	16	22 3/4	1 1/8-8UN	415	DAJ
20	23	17 7/16	15 7/16	8	5	4 5/16	N/A	2 1/4	17 5/8	1/2 X 3/8 X 4	6 1/2	4	13/16	20	25	1 1/8-8UN	500	DAK
24	27 1/2	19 11/16	17 13/16	8	6 1/16	4 1/4	2 1/4	2 1/2	21 1/16	1/2 X 3/8 X 4	6 1/2	4	13/16	20	29 1/2	1 1/4-8UN	750	DAK
30	33 3/4	24 1/2	21 3/16	9 1/2	7 3/8	7	N/A	3	26 7/8	3/4 X 3/4 X 6	9 3/4	4	1 1/16	28	36	1 1/4-8UN	1,360	MAZ
36	40 1/4	28 3/8	24 11/16	9 1/2	8 1/2	8	N/A	3 1/2	33 5/16	7/8 X 7/8 X 5 11/16	9 3/4	4	1 1/16	32	42 3/4	1 1/2-8UN	2,250	MBE

Note:

* E.N.P. discs require larger upper stem connection diameters on 6 inch and 10 inch valve sizes for UHMWPE seat, metal seat and fire-safe seat trims.

ASME Class 300 Figure 372 Dimensions (inches)

Size	A	B	C	D	E	F	G	H	Q	Top Plate Drilling			Tapped Lug Data			Wt. Lbs.	Actuator Code	
										DD or Keyway	Bolt Circle	No. Holes	Hole Dia.	No. Holes	Bolt Circle			Tap
2	4 1/8	6	4 1/4	4	2 3/8	1 1/4	N/A	9/16	1 7/8	3/8	3 1/4	4	7/16	8	5	3/4-10UNC	17	BAB
2 1/2	4 1/8	6	4 1/4	4	1 7/8	1 1/4	N/A	9/16	2 5/16	3/8	3 1/4	4	7/16	8	5 7/8	3/4-10UNC	18	BAB
3	5	6 5/8	4 13/16	4	1 7/8	1 1/4	N/A	5/8	2 11/16	7/16	3 1/4	4	7/16	8	6 5/8	3/4-10UNC	20	BAC
4	6 3/16	7 1/2	5 13/16	4	2 1/8	1 1/4	N/A	3/4	3 11/16	1/2	3 1/4	4	7/16	8	7 7/8	3/4-10UNC	26	BAD
5	7 1/4	7 9/16	5 13/16	4	2 5/16	1 1/4	N/A	3/4	4 3/4	1/2	3 1/4	4	7/16	8	9 1/4	3/4-10UNC	31	BAD
6	8 19/32	8 3/4	6 15/16	6	2 5/16	1 1/4	N/A	7/8	5 5/8	5/8	5	4	9/16	12	10 5/8	3/4-10UNC	55	CAE
8	10 5/8	10 1/8	8 3/8	6	2 7/8	2	N/A	1 1/8	7 7/16	1/4 X 1/4 X 1 5/8	5	4	9/16	12	13	7/8-9UNC	80	CAF
10	12 3/4	11 3/8	9 11/16	6	3 1/4	3	N/A	1 3/8	9 9/8	5/16 X 5/16 X 2 5/8	5	4	9/16	16	15 1/4	1-8UN	137	CAG
12	14 3/4	13	10 7/8	8	3 5/8	3	1 3/8	1 1/2	11 1/4	5/16 X 5/16 X 2 5/8	6 1/2	4	13/16	16	17 3/4	1 1/8-8UN	185	DAG
14	16 1/4	14 3/8	12 5/8	8	4 5/8	4 1/4	N/A	1 7/8	12	1/2 X 3/8 X 4 1/8	6 1/2	4	13/16	20	20 1/4	1 1/8-8UN	340	DAJ
16	18 1/2	16 1/16	13 3/4	8	5 1/4	4 1/8	N/A	2 1/4	13 5/8	1/2 X 3/8 X 4	6 1/2	4	13/16	20	22 1/2	1 1/4-8UN	432	DAK
18	21	17	15 1/8	8	5 7/8	4 7/32	N/A	2 1/2	15 7/16	5/8 X 5/8 X 4	6 1/2	4	13/16	24	24 3/4	1 1/4-8UN	550	DBA
20	23	20 3/16	16 3/4	7 1/2	6 1/4	6 1/2	N/A	2 3/4	17 1/4	5/8 X 5/8 X 6 3/8	8	4	13/16	24	27	1 1/4-8UN	850	LAX
24	27 1/4	23 3/8	19 13/16	9 1/2	7 1/8	6 13/16	N/A	3 1/2	20 3/4	7/8 X 7/8 X 5 11/16	9 3/4	4	1 1/16	24	32	1 1/2-8UN	1,278	MAY
30	33 3/4	26 5/8	24 9/16	10	9 1/2	7 7/8	N/A	4 1/2	26	1 X 1 X 6 1/2	10	4	1 1/8	28	39 1/4	1 1/4-8UN	2,450	NAW
36	40 1/4	30 7/8	28 7/16	12 1/4	10 3/4	8	N/A	5	32 7/16	1 1/4 X 1 1/4 X 7	12	4	1 1/8	32	46	2-8UN	2,850	EBD

Pressure/Temperature Ratings for Seat Materials

Elastomer Seats

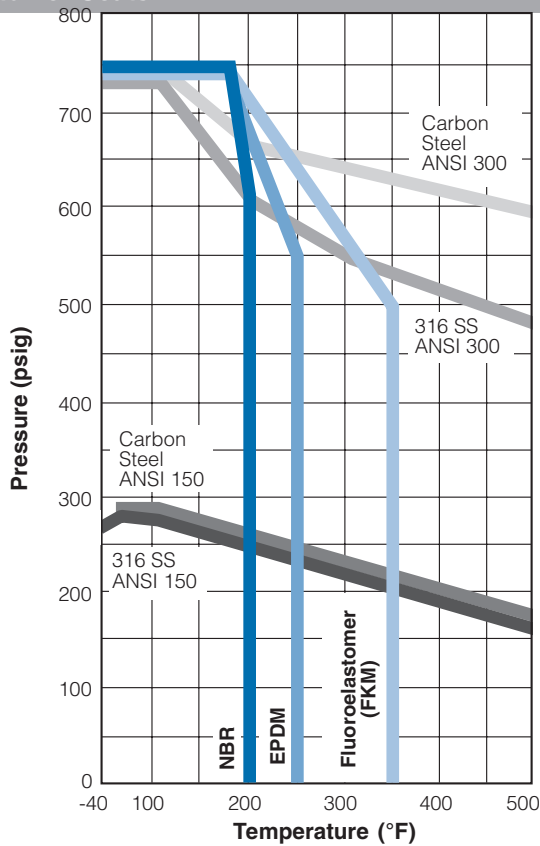

Polymer Seats

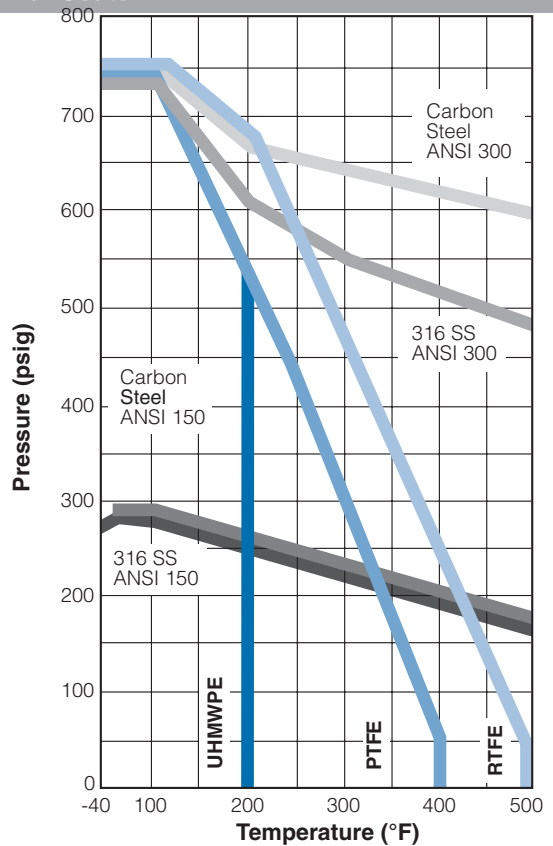

Fire-Safe and Metal Seats

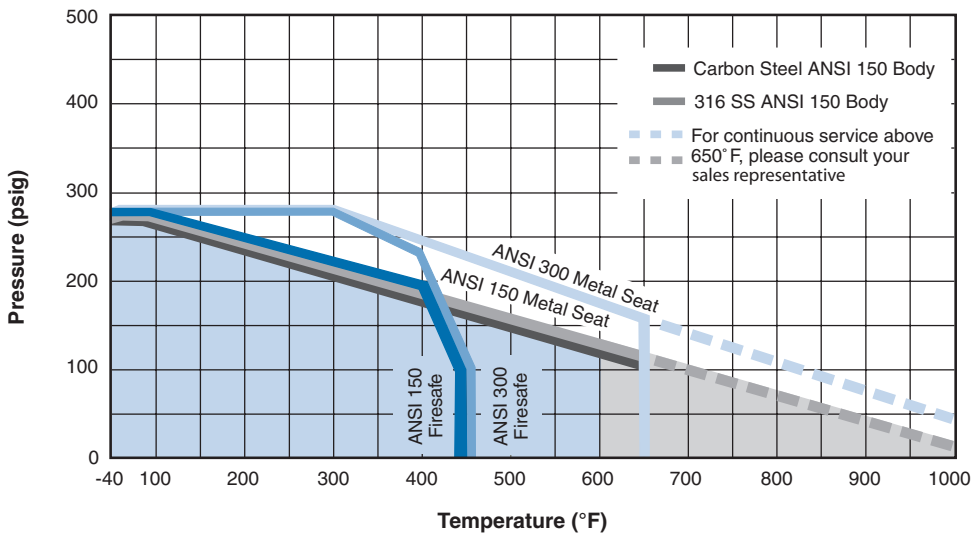

www.keystonevalves.com

Tyco Flow Control (TFC) provides the information herein in good faith but makes no representation as to its comprehensiveness or accuracy. This data sheet is intended only as a guide to TFC products and services. Individuals using this data sheet must exercise their independent judgment in evaluating product selection and determining product appropriateness for their particular purpose and system requirements. TFC MAKES NO REPRESENTATIONS OR WARRANTIES, EITHER EXPRESS OR IMPLIED, INCLUDING WITHOUT LIMITATION ANY WARRANTIES OF MERCHANTABILITY OR FITNESS FOR A PARTICULAR PURPOSE WITH RESPECT TO THE INFORMATION SET FORTH HEREIN OR THE PRODUCT(S) TO WHICH THE INFORMATION REFERS. ACCORDINGLY, TFC WILL NOT BE RESPONSIBLE FOR DAMAGES (OF ANY KIND OR NATURE, INCLUDING INCIDENTAL, DIRECT, INDIRECT, OR CONSEQUENTIAL DAMAGES) RESULTING FROM THE USE OF OR RELIANCE UPON THIS INFORMATION. All Patents and Patents Pending in the U.S. and foreign countries are property of their respective owners. Tyco reserves the right to change product designs and specifications without notice. All registered trademarks are the property of their respective owners. Printed in the USA.