

A large industrial facility, possibly a power plant or refinery, with a worker in the foreground. The worker is wearing a dark jacket, a plaid shirt, and a white hard hat. They are holding a black mallet with a wooden handle. The background shows a complex of pipes, machinery, and structural steel under a high ceiling with industrial lighting. A green banner is overlaid on the top left of the image.

**Focus on reliability to improve  
availability, profitability and safety.**

## **Prediction and Protection for Production Assets**

Recognize business goals and achieve top-quartile reliability by implementing predictive intelligence and integrated protection technologies





# Unreliable equipment increases risk to both safety and profits

Unscheduled downtime caused by equipment failure eats into both the maintenance budget and production goals. Routine maintenance can help, but it doesn't reveal the developing issues that result in process slowdowns or shutdowns. You simply aren't able to avoid these preventable failures.

Introducing technology to monitor these assets sounds like the solution, but where do you start? The budget won't allow you to install the same monitoring system on every asset in the plant, so how would you choose what equipment to monitor and what equipment to ignore?

In addition, your critical assets are required to have API-certified protection systems so the equipment is tripped under unsafe operating conditions. But sometimes those trips aren't necessary – and again your production is shutdown while you determine the nature of the problem.

To keep your plant assets available and producing revenue, you need solutions that are custom to the criticality of the asset being monitored and that identify the assets at risk of failure.



A typical refining facility will spend **less than 10%** of its time in **transient operations**. However, **50%** of all process safety **incidents occur during this time**.  
– *Tame your Transient Operations, Chemical Processing June 2010.*



It costs approximately **50% more to repair** a failed asset than if the problem had been addressed prior to failure.  
– *U.S. National Response Center*



Production capacity is lost to as much as **5% every year as a result of unplanned shutdowns**.  
– *Asdza Nadleeh, "Engineering & Maintenance: Prevention is Better Than Cure," Oil & Gas IQ, October 2011.*



# Focus on reliability to improve availability, profitability, and safety

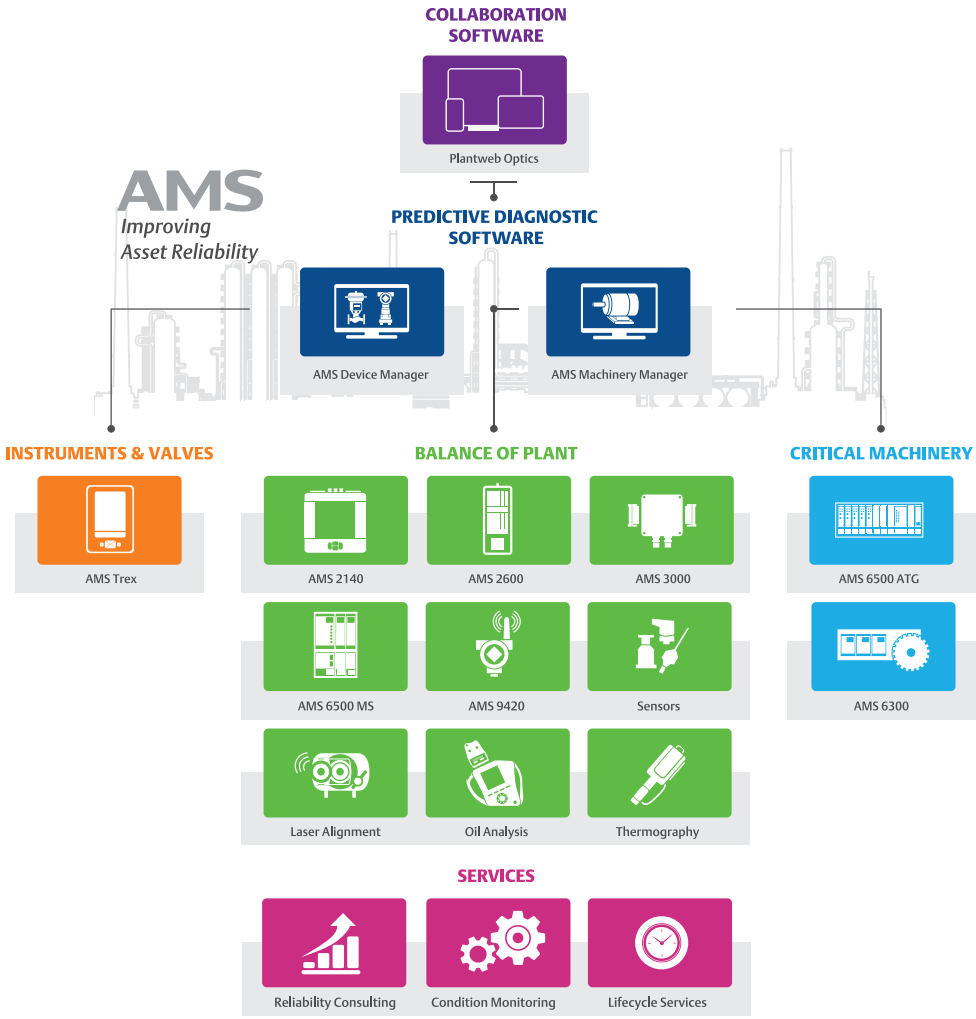

## Drive equipment reliability using smart field devices.

Proactively managing your field device assets so that they are accurately configured and calibrated is key to ensuring the value of their predictive diagnostics. With effective asset management and predictive intelligence, you can focus on driving equipment performance.

## Ensure safer operation by combining prediction with protection.

When your plant requires protection on its critical assets, Emerson integrates API-compliant protection with continuous predictive monitoring technology so you can operate your plant safely and with confidence. Extend protection to other assets in your plant with application specific or right-sized systems.

A key strategy to improving reliability is to monitor the condition of both production and automation assets in your plant. Emerson offers a variety of condition indicator technologies specific to the nature and criticality of those assets – portable handheld and asset management solutions, wireless transmitters, and online continuous monitoring systems that can include protection capabilities.

- Machinery Health Management combines condition monitoring technologies with predictive intelligence to reduce both scheduled and unscheduled downtime of your rotating equipment.
- Field Device Management utilizes configuration and calibration data to confirm your automation assets are operating effectively, thereby protecting the reliability of your production assets.

## Cut maintenance costs with predictive intelligence.

It costs approximately 50% more to repair a failed asset than if the problem had been addressed prior to failure. Predictive intelligence from condition indicators improves overall plant reliability by reducing scheduled and unscheduled downtime, driving down maintenance costs and increasing safety and availability.

## Improve the accuracy of your analysis.

Improving reliability requires analyzing all kinds of data. But the analysis can only be as good as the data it relies on. Whatever kind of measurement is required – acceleration, velocity, displacement, speed or pressure – must be counted on for quality and accuracy to avoid “garbage in, garbage out”.





## Improve asset reliability using predictive field diagnostics

In a perfect world, your process would be consistent, day in and day out. But the reality is that field device performance, like most things, can degrade over time. Variability is a natural occurrence that must be dealt with.

Predictive diagnostics from field devices help your maintenance team keep sensing devices configured, calibrated, and operating effectively. And the measurements and control from those devices protect the reliability of your production equipment. Emerson's AMS Device Manager provides real-time online access to intelligent instrument and valve diagnostics and alerts, delivering a view of device health and troubleshooting information when an issue is found. The AMS Trex Device Communicator and 475 Field Communicator allow your personnel to assess health and repair devices from the field. Whether online or offline, Emerson gives you the tools to ensure your field devices are performing as expected.

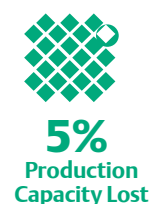

### What's your challenge?

Production capacity is lost to as much as 5% every year as a result of unplanned shutdowns.

– Asdza Nadleeh, "Engineering & Maintenance: Prevention Is Better Than Cure," Oil & Gas IQ, October 2011.



### What's your opportunity?

Even small fixes have big impact. While using AMS Device Manager, Braskem S.A. found a calibration error on a pressure control valve, causing the valve to open 3% when it was supposed to be closed. Fixing the calibration error saved the plant \$300,000 a year.

– Braskem S.A. in Brazil

## Improve the effectiveness of your maintenance team



**Predictive diagnostics** help personnel focus their efforts on the assets that need attention, while eliminating unnecessary work on healthy devices.

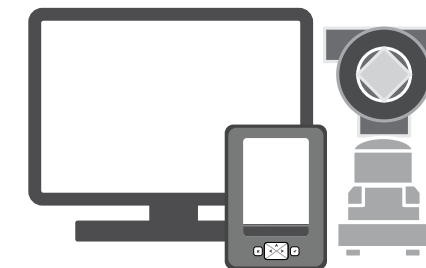

**Troubleshoot problems** directly from the maintenance shop or in the field. Troubleshooting advice helps technicians solve the problem quickly.



**Easily prioritize work** based on the criticality of the asset and the urgency of the alert. Ensure technicians are spending time on the production critical issues.

## Reduce configuration/commissioning time

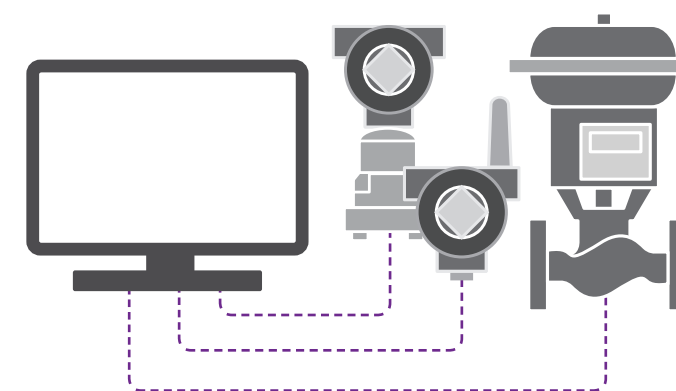

**Use device templates** to set up once and configure many, reducing set up errors and improving commissioning efficiency.

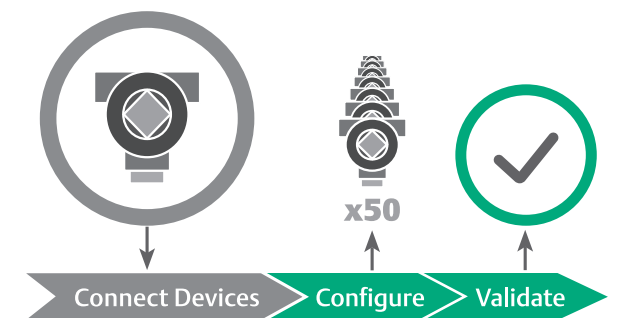

**Configure in bulk** to reduce commissioning time by up to 80%. Once device templates are complete, apply to common devices simultaneously. Then validate configurations quickly with a discrepancies report.

## Streamline calibration work processes and reduce errors



**Eliminate paper-based calibration** by electronically managing routes with AMS Device Manager to reduce calculation and documentation errors.

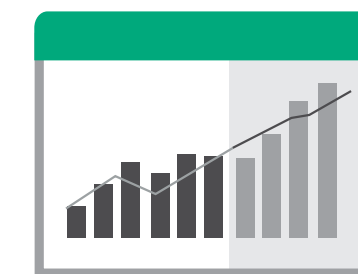

**Extend calibration intervals** while remaining compliant using historical drift trends in AMS Device Manager. Eliminate the unnecessary effort of scheduled-based calibration.

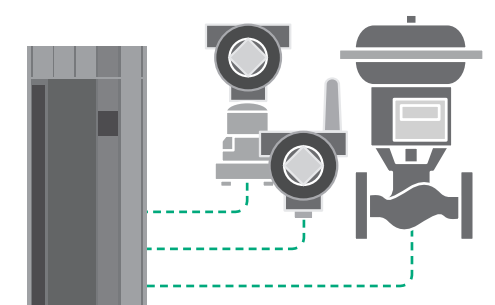

**Centralize device data** in a single database to enable better analysis of health and performance and improved resource planning and scheduling.





## Drive success using predictive intelligence

When your assets aren't reliable, you can't maintain your schedule or operate within budget. Your assets become the drivers of your success. But with predictive intelligence, you gain the insight necessary to schedule maintenance that supports your production goals. Emerson's technology for delivering predictive intelligence puts you back in the driver's seat.

Vibration data is the cornerstone of predictive intelligence. Emerson offers accurate, industry-proven technology for data collection and field analysis of vibration data on a wide range of rotating assets. Factors such as asset criticality and location determine whether the technology is applied periodically or continuously. Vibration data can be routed back to the control room where operators can easily leverage both asset condition and process data to make educated production decisions.

Emerson's vibration data collection technologies feature a unique methodology - PeakVue technology - to cut through the complexity of machinery analysis and provide a simple, reliable indication of equipment health that is easily understood by both operations and maintenance.

**50%  
MORE**  
Repair Costs

### What's your challenge?

It costs approximately 50% more to repair a failed asset than if the problem had been addressed prior to failure.

– U.S. National Response Center

**5%  
Reduction in  
maintenance  
cost**

**Reduction in  
maintenance  
cost**

### What's your opportunity?

Reduce repair expense. By making use of predictive data to improve the reliability of their rotating equipment, Saudi Aramco, Ras Tanura refinery, reported a total program savings of over \$10 million annually and a 9% reduction in maintenance costs.

– Saudi Aramco, Winner  
– Reliability Program of the Year 2015.

## Safeguard critical assets 24/7 with online monitoring



**Continuous monitoring of both critical and balance of plant assets** provides real-time machinery health feedback to the DCS – either integrated via AMS 6500 to DeltaV, or embedded as an Ovation Machinery Health Monitor.

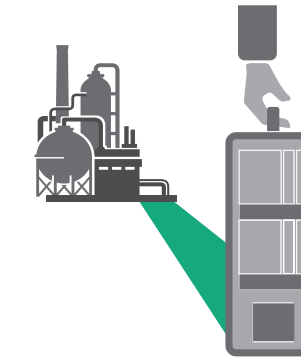

**Troubleshoot problems** on critical assets without the expense of a permanent monitoring system using the AMS 2600.

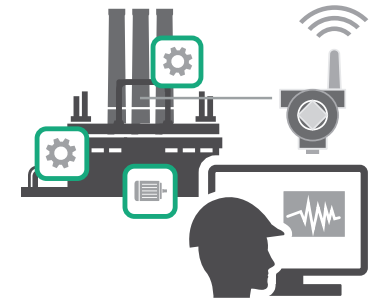

**Wireless vibration monitoring** using the AMS 9420 extends the maintenance program to remote or hazardous locations with minimal installation costs.

## Maintain availability through periodic monitoring

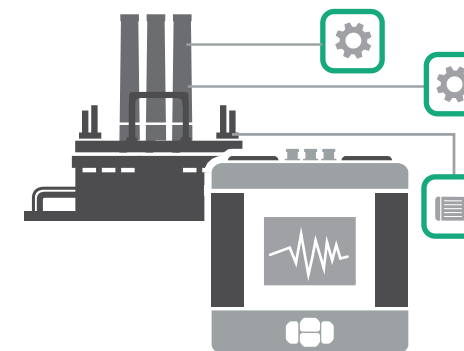

**Route-based monitoring** using the AMS 2140 maintains production-essential assets and allows for sophisticated diagnostic testing while in the field.

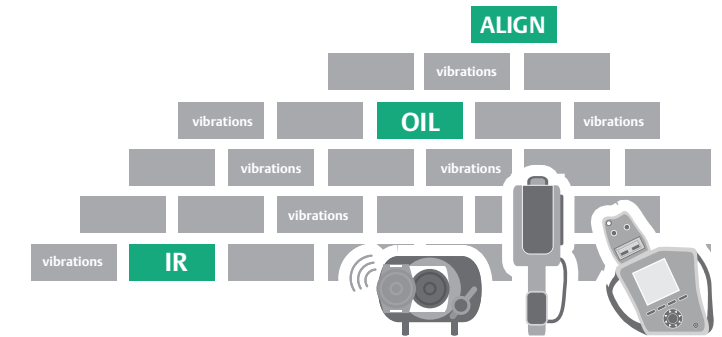

**Integration of complementary technologies** such as infrared thermography, oil analysis, and laser alignment capabilities creates a complete picture of machinery health.

## Supplement your team with expertise and manpower



**Machinery condition monitoring services** utilize a global network of vibration and oil analysis experts to remotely analyze your data.



**Scheduled onsite services** provide additional manpower to perform a wide range of maintenance services.

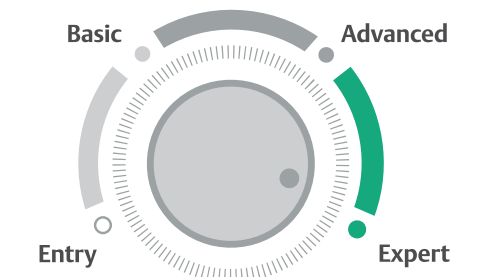

**Hands-on training** with proven educational tools elevates your team's expertise and ensures your plant's performance levels.





## Accomplish more with your protection system

Safety regulations and often insurance requirements necessitate the installation of a shutdown system on your expensive and critical production assets to protect both lives and investments. But protection doesn't have to be just a necessary expense – the right protection system can be a path to integrating the predictive intelligence that allows you to avoid false or missed trips.

Through system integration and unique data access, Emerson protection systems allow you to confidently determine when critical assets can be allowed to continue running safely.

By recording data during equipment start-ups, coast downs, and other transient events, Emerson protection systems provide you the information necessary to make informed operational decisions. Systems are compliant to a variety of API standards and SIL environments, meeting the strict safety and insurance requirements such as those in the refining and petrochemical industries.



### What's your challenge?

A typical refining facility will spend less than 10% of its time in transient operations. However, 50% of all process safety incidents occur during this time.

– *Tame Your Transient Operations*,  
Chemical Processing June 2010



### What's your opportunity?

Operate safely during typically dangerous conditions. The startup and coastdown of turbo machinery is potentially the most dangerous operating state due to the rapidly changing conditions. Rather than just snapshots of data, Emerson delivers real-time data on multiple channels simultaneously for the most powerful, accurate diagnostics and safer operating conditions.

## Integrate predictive intelligence with protection capabilities

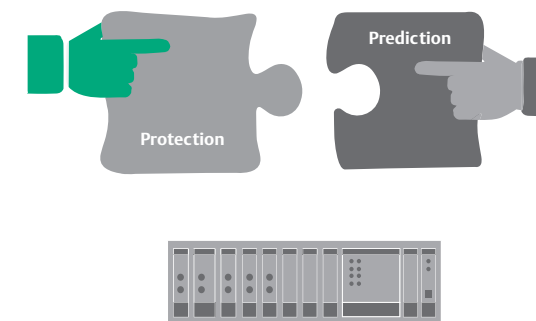

**Industry-leading protection capabilities** in the AMS 6500 ATG include highly flexible data acquisition cards that can be configured to collect data for predictive intelligence and advanced diagnostics.

## Extend protection to more or specific applications



**Overspeed conditions** caused by a sudden loss of load are guarded against by the AMS 6300 SIS Digital Overspeed system.

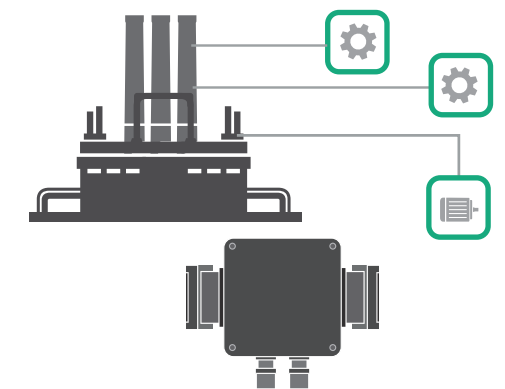

**Field-mounted, dual-channel protection** from the AMS 3000 delivers basis protection directly to a machine wherever a standard rack-based system doesn't apply.





## Implement IIoT in your reliability program

The Industrial Internet of Things (IIoT) has arrived. Technology advances make it easier than ever to stay on top of asset health and stay in touch with the personnel who care about their performance – no matter where they are. But implementing IIoT can be a daunting task – where do you start? How do you bring together the silos of data in your plant without inundating the team with hundreds of alerts? You need a solution that promotes collaboration while still streamlining decision-making when problem calls for quick action.

Plantweb Optics is a software application that aggregates data from multiple sources, but delivers persona-based alerts and KPIs for improving reliability of your rotating equipment, instruments and valves. With additional connectivity to CMMS, advanced analytical tools, and other predictive intelligence programs, you'll stay on top of developing issues that could impact production. Anywhere, anytime.

 **60%** of global manufacturers used analytics data recorded from connected devices to analyze processes and identify optimization possibilities\*

\*Source: IDC and SAP, as reported By Kelvin Claveria, 13 Stunning stats on the Internet of Things, Vision Critical blog, April 2017

**\*IIoT will lead to a 15% productivity increase in delivery and supply chain performance**

## The platform for integrating and communication asset health information

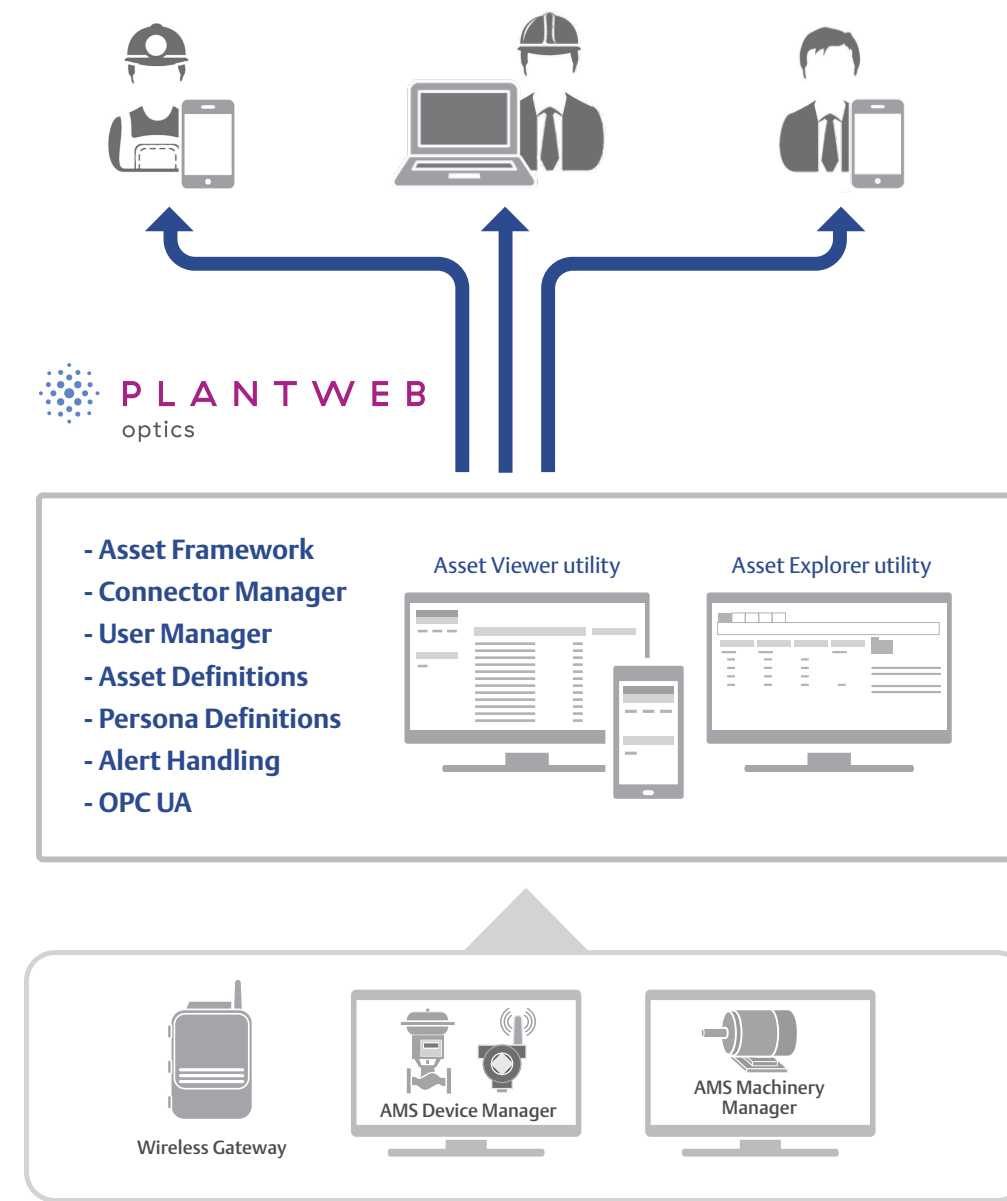

## Easy to setup, easy to use

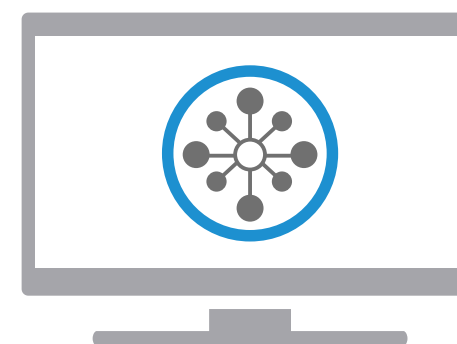

The **Asset Explorer** utility features an intuitive user interface for performing a wide range of setup and configuration activities, such as added machine trains, assigning roles and responsibilities, and much more.

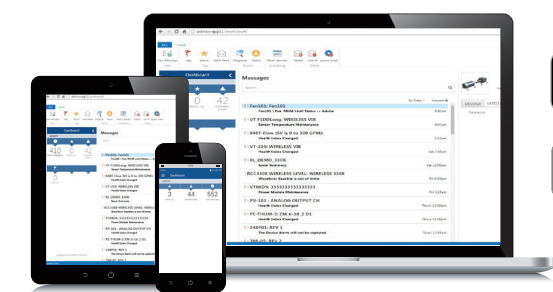

The **Asset Viewer** utility runs on laptops, tablets and smart phones to deliver the right information at the right time.



# One source of responsibility for the entire measurement chain

When there is a problem with your data, where is the source – your sensor? Your collection system? When your tools come from multiple vendors, it can sometime be difficult to pinpoint the responsibility and address the problem.

Emerson offers a full line of quality sensors to complement its prediction and protection systems. Working with a leading third-party sensor supplier, Emerson has introduced a variety of specialized sensors to improve the accuracy of the measurement as well as the ability to physically capture early stage asset failure data.

Emerson’s sensor portfolio includes:

**Accelerometers –**

Emerson offers a wide range of options for all applications and budgets.

**Displacement sensors, converters and transmitters –**

Options range from field and enclosure mountings, small and large shaft measurements, and industrial safety ratings.

**Velocity, Pressure, and Speed Sensors –**

Application-specific sensors that support a more complete look at asset health.



## Eddy Current Measurement Made Easy

Historically, the various elements of an eddy current measurement chain have been expensive to keep on hand for replacement or outage planning. Factory-required calibration of the converter meant dozens of spare parts or long lead times for replacements. The new AMS EZ 1000 sensor can be calibrated in the field for most applications with a simple button push. Converter calibration makes use of a USB interface back to Emerson’s Machine Studio for a simple three-step configuration process.

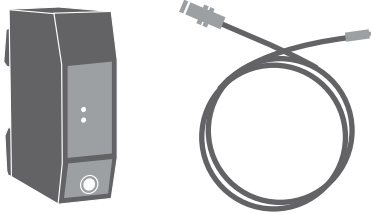

## Cut through the complexity of machinery analysis

Emerson’s PeakVue technology cuts through the complexity of machinery analysis to provide a simple, reliable indication of equipment health via a single trend. PeakVue filters out traditional vibration signals to focus exclusively on impacting, a much better indicator of overall asset health on pumps, fans, motors or any other type of rolling element bearing machine. As a measure of impacting, PeakVue readings are much easier to interpret. A good machine, properly installed and well lubricated, should normally not show any impacting.

As common machinery faults begin to appear on rotating equipment (e.g. rolling element bearing defects, gear defects, insufficient lubrication, or pump cavitation), the PeakVue reading typically can be evaluated using a Rule of 10’s. A 10g reading indicates a developing problem, 20g a serious problem, and so on up to 50g’s where failure is imminent. Using these principles, operators with no special training in machinery diagnostics can quickly and easily determine when a piece of rotating equipment is healthy and when an abnormal situation is present.



# Impacting the bottom line

Implementing predictive intelligence and protection technologies from Emerson will deliver positive results in reduced scheduled and unscheduled downtime. For companies pursuing top-quartile reliability, the return on investment is huge.

A study\* of reliability practices measured maintenance costs as a function of the replacement value of the assets. If a top-performing site spends 10 million dollars per year on maintenance, a poor performing plant will spend 3 1/2 times more for the same size plant. Top-quartile plants also experience very little downtime as a result of equipment problems, while fourth quartile (poorest) performers experience disruptive levels of down time that is almost 15% greater than top performers.

Top-quartile performers also demonstrate an integrated set of elements shown in the Reliability Value Chain. Ultimately, the ability to achieve top performance status is dependent on the robustness of each element and, perhaps more importantly, on the effective connectedness of all of the elements into a continuous improvement cycle.



\*2013 Solomon RAM Study, Solomon Associates, LLC.



**Emerson is your partner for implementing the Reliability Value Chain by providing:**

- Condition indicators and asset health analysis tools that drive information towards action.
- Consulting services to assist in the development of foundational data and enterprise-wide reliability management programs.

Emerson's Reliability Consulting delivers comprehensive, scalable asset management and reliability services to diverse industries. Core competencies are centered on two skill sets: reliability engineering and data integrity. Mastery in each skill set allows Emerson to serve clients independently in each area, or with a combined expertise to implement reliability on an enterprise scale.



**43% DOWNTIME**  
 As much as 43% of unplanned downtime is caused by equipment failure

-Large Property Damage Losses in the Hydrocarbon-Chemical Industries, 17th Edition.

**60-80% of the total life cycle costs**

Operations and Maintenance costs are between 60-80% of the total life cycle costs for a given asset.

-Maintenance & Reliability Best Practices by Ramesh Gulati, 2012





## Partner with Emerson to Achieve Top-Quartile Reliability

### Protect and expand the value of your technology investment

While many companies recognize a significant ROI following their technology implementation, companies that commit to maintaining their technology advantage reap the benefits for years to come.

#### Guardian Support Services

Improving reliability in the plant requires more than just acquiring the right monitoring and analysis technologies. You need to actively manage those investments and their lifecycle costs. Emerson offers Guardian Support services designed to optimize the reliability and performance of your machinery health products. Specific, critical information is matched to your system and proactively delivered to you through a secure dashboard portal available 24x7x365. Guardian Support also delivers incident management with access to experts to help you through critical issues. An accurate inventory of all system components and licensing combined with in-depth documentation and resources aids in your troubleshooting.

#### Educational Services

Companies today rely on fewer people to do more work. The need for training is more critical than ever to achieve and maintain cost effective maintenance programs. Emerson helps maximize the return on your investment in technology and people. Our goal is to provide you with the knowledge to keep your plant running smoothly.

### PolyOne success

Emerson clients achieve measurable results by implementing strong enterprise-wide standards. PolyOne Corporation, a premier global provider of specialized polymer materials, partnered with Emerson to leverage, set and apply standards for performing maintenance, ascertaining equipment conditions, and measuring performance across 50 plant sites. In addition to being recognized by Uptime magazine as the best emerging reliability program of the year for 2014, they also recognized:

- Reduced maintenance spending by 12%
- Safety incident rate nine times better than industry benchmark
- Planned vs. corrective work orders increase from 45% to 64%
- On-time deliveries reaching an all-time high of 95.4%

### Saudi Aramco success

Top-quartile reliability requires more than just technology investments. At Saudi Aramco's Ras Tanura Refinery, the decision and commitment to instilling a reliability culture from the top down netted significant improvements over a short two-year period. Their people-centric, multi-tiered approach included a multi-disciplinary reliability team, roadmaps for improving reliability of problematic rotating equipment, development of key performance indicators (KPIs), and internal "boot camps" focused on the benefits of reliability and continuous improvements. The facility was named Emerson's 2015 Reliability Program of the Year winner based on their program and documented results:

- Total annual savings of over \$10 million
- Reduced preventative maintenance manhours by 24%
- 180% increase in defects identification
- 20% increase to air system efficiency
- Elimination of \$7 million in energy waste problems, while fourth

### Greenfield Ethanol

The team at Greenfield Ethanol's facility in Varennes, Quebec recognizes that reliability is a journey and values both maintaining and evolving a strong reliability plan. Their emphasis on continuous improvement across operations, maintenance, logistics, production and all other sectors has helped them to out-perform competitive facilities with larger staffs. From the time the facility opened, management supported a strong reliability program as part of their planned expansion. Greenfield Ethanol was named Emerson's 2016 Reliability Program of the Year based on their program approach and measurable results achieved over their eight years of operation:

- Production increased by 80%, while maintenance costs only increased by 14%.
- Overall energy costs are 74% of what they were in the plant's first year of operation even though energy cost increases should have them at 180%.



# Improve availability, profitability and safety using Emerson's Reliability Solutions.

## AMS

**Emerson – Reliability Solutions North America**  
835 Innovation Drive  
Knoxville, TN 37932 USA  
☎ +1 865 675-2400

**Emerson – Reliability Solutions South America**  
Av. del Valle 601, 4to piso,  
Ciudad Empresarial,  
Santiago Chile  
☎ +56 2 4310-7432

**Emerson – Reliability Solutions Europe**  
Katzbergstr. 1  
40764 Langenfeld (Rhld.)  
☎ +49 0 2173 3348 0  
☎ +49 0 2173 3348 100

**Emerson – Reliability Solutions Asia/Australia**  
1 Pandan Crescent  
Singapore 128461  
☎ +65 6777 8211  
☎ +65 6777 0947

**Emerson – Reliability Solutions Middle East/Africa**  
PO Box 17033  
Dubai - United Arab Emirates  
☎ +971 4 811 8100  
☎ +971 4 886 5465

🌐 [www.emerson.com/ams](http://www.emerson.com/ams)

©2016-2018, Emerson. All rights reserved.

The Emerson logo is a trademark and service mark of Emerson Electric Co. All other marks are the property of their respective owners.

The contents of this publication are presented for informational purposes only, and while diligent efforts were made to ensure their accuracy, they are not to be construed as warranties or guarantees, express or implied, regarding the products or services described herein or their use or applicability. All sales are governed by our terms and conditions, which are available on request. We reserve the right to modify or improve the designs or specifications of our products at any time without notice.

AMS\_BR\_PredictionProtectionProductionAssets\_0618



**EMERSON. CONSIDER IT SOLVED.™**